

ACCESSORIES COUPLING AND FITTINGS

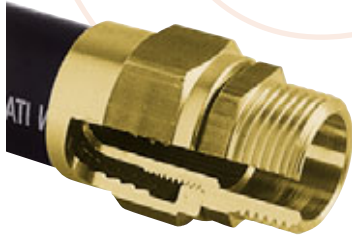

Union re-usable coupling



PRODUCTS' RANGE

Code	Description	Inlet/Outlet			Key 1	Key 2
		A BSP	B mm	C mm		
Swivel						
000890000	Union 34.27	3/4"	19	27	25	38
000891000	Union 1.27	1"	19	27	94	31
000892000	Union 1.35	1"	25	35	38	38
000893000	Union 34.32	3/4"	19	32	34	31
000894000	Union 1.32	1"	19	32	34	38
000895000	Union 1.38	1"	25	38	94	38

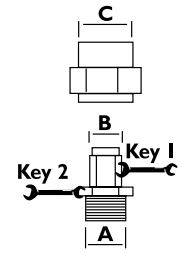

1



2



3



4

HQC Hose Quick Coupling

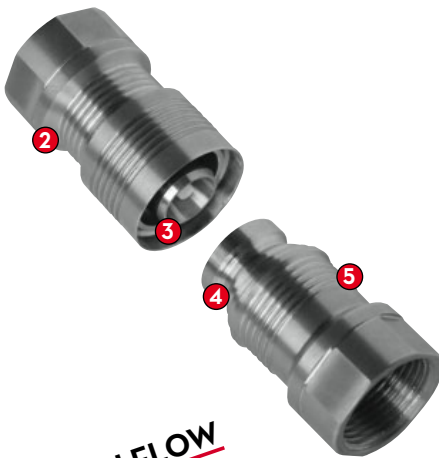

HIGH FLOW

EN. Hose quick coupling PIUSI has developed a new quick coupling that is suitable for use with diesel. In the past, quick couplings for use with diesel derived from quick couplings that were intended for use with oil, where the bores on the interior were too small for the diesel supply flow. With this quick coupling, this issue does not come into play. Here the bore has been designed to minimise resistance in the presence of high flow rates during the supply of the diesel.

1 - Fully closed position
2 - Open position
3 - Male coupling
4 - Female coupling
5 - Embossed profile: improves grip for coupling/uncoupling.

ES. Conexión rápida para tubo PIUSI ha desarrollado una nueva conexión rápida apta para el uso con gasóleo. En el pasado, las conexiones rápidas para gasóleo derivaban de conexiones rápidas para aceite y los orificios internos no eran lo suficientemente grandes para el caudal del suministro del gasóleo. Hoy, el orificio de esta conexión rápida ha sido diseñado para reducir al mínimo la resistencia en presencia de altos caudales durante el suministro del gasóleo.

1 - Posición todo cerrado
2 - Posición abierta
3 - Conexión macho
4 - Conexión hembra
5 - Perfil en relieve: mejora el agarre en fase de enganchar/desenganchar.

PT. Engate rápido para tubo A PIUSI desenvolveu um novo engate rápido apropriado para utilizar com gasóleo. Antigamente os engates rápidos para gasóleo derivavam de engates rápidos para óleo e os furos interiores não eram suficientemente grandes para a vazão do abastecimento do gasóleo. Agora o furo deste engate rápido foi projectado para diminuir ao mínimo a resistência com as vazões grandes que há durante o abastecimento de gasóleo.

1 - Posição inteiramente fechado
2 - Posição aberto
3 - Engate macho
4 - Engate fêmea
5 - Perfil em relevo: mais fácil de segurar na fase de enganchar/desenganchar.

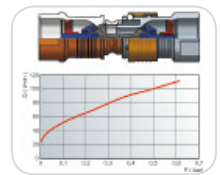

EN. Moulded internal profile: reduces pressure loss.

ES. Perfil interno conformado: reduce las pérdidas de carga

PT. Perfil interior moldado: diminui as perdas de carga.

PRODUCTS' RANGE

Code	Description	Weight	Pack.	Packaging
		Kg	pcs. no.	mm
HQC				
F00636000	HQC Hose Quick Coupling 1"	0,46	1	80x80x75

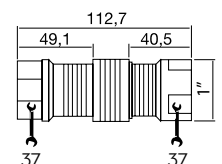

PRODUCTS' RANGE
Elbows

Code	Description	A	B	Q.ty	Key
Elbows					
F07806000		F 3/4" BSP	F 3/4" BSP	-	-
F07805000		M 3/4" BSP	F 3/4" BSP	-	-
F08609000		F 1" BSP	F 1" BSP	-	-
F07988000		M 1" BSP	F 1" BSP	-	-
F14279000	Inox	M 1" BSP	F 1" BSP	-	-

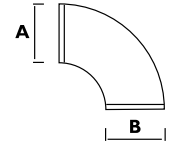
Hose tails

Inox Version

Hose tails					
F0826700A		1/2" BSP	19 mm	1	27
F0643700A		3/4" BSP	19 mm	20	32
F0776800B		3/4" BSP	25 mm	20	32
F0775700A		1" BSP	19 mm	20	37
F0776400A		1" BSP	25 mm	20	37
F14122000	Inox	M 1" BSP	19 mm	1	37
F14123000	Inox	F 3/4" BSP	19 mm	1	37

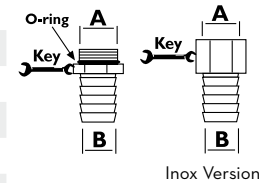

Inox Version

Rotating hose tails - Inox

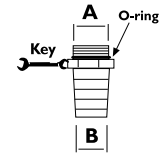

Rotating hose tail - Inox					
F14132000	Inox	3/4" BSP	19 mm	-	27

Sleeve

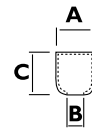

Sleeve					
F08137000		28 mm	20 mm	-	30
F08138000		36 mm	28 mm	-	35

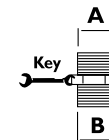
Sleeve

Sleeve					
F07766000		M 3/4" BSP	M 3/4" BSP	-	27
F07765000		M 1" BSP	M 1" BSP	-	34

Reducing sockets

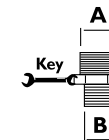
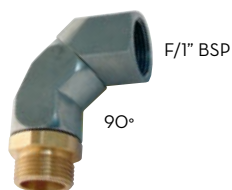
Reducing sockets					
F07441000		F 1/2" BSP	M 3/4" BSP	-	30
F07762000		M 3/4" BSP	M 1" BSP	-	34
F08913000		M 1" BSP	M 1 1/2" BSP	-	50
F07760000		F 3/4" BSP	M 1" BSP	-	35
F07889000		F 1" BSP	M 3/4" BSP	-	34
008891000		F 1" BSP	M 2" BSP	-	60

Elbow rotating connector

M/1" BSP

 Code **F14567000**
Sealant paste

Code	Description		Q.ty
F08173000	Light removable	g. 130	1
F10767000	Medium removable	ml. 250	1
F12278000	Heavy non removable	ml. 250	1

